



# SLIMLINE PANEL HEATERS

## Installation And Operation Instructions



**Model Number**  
OSPH1000E/1500E/2000E

Thank you for purchasing this Osily Convector Heater. Please read these instructions before installation or operation and leave with the appropriate person for future retention.

**OSPH1000E/1500E/2000E Slimline Panel Heater  
Installation & Operating Instructions**



**DO NOT COVER**

**IMPORTANT SAFETY INFORMATION**

**WARNING:** In order to avoid overheating, do not cover the heater. We recommend that this appliance is installed by a qualified electrician in accordance to the current wiring and building regulations.

- /// This appliance is intended for internal use only in domestic and small commercial applications and warnings must be adhered to.
- /// Do not cover the heater. Never cover or obstruct in any way the heat outlet slots at the top of the heater or the air inlet slots in the base of the heater.
- /// This appliance can be used by children aged from 8 years and above and persons with reduced physical, sensory, or mental capabilities or lack of experience and knowledge if they have been given supervision or instruction concerning use of the appliance in a safe way and understand the hazards involved.
- /// Children shall not play with the appliance. Cleaning and user maintenance shall not be made by children without supervision.
- /// Some parts of this appliance can become very hot and cause burns, please ensure that the heater has been switched off and allowed to cool before cleaning etc.
- /// If the supply cord is damaged, it must be replaced by the manufacturer, its service agent or similarly qualified persons in order to avoid a hazard
- /// Please do not use the product for any other purpose. Do not use this product with an extension lead or multi plug adapter.
- /// For your safety, this heater is fitted with a thermal cut-out. If the product overheats for some reason, the cut-out prevents excessive temperatures on the product by cutting the power to the heater.
- /// There are no user serviceable parts in this appliance.
- /// Please unplug and ensure that the unit is disconnected from the mains supply before any attempt to open the case or any part of this heater

## Setting the Heater

- This heater is intended for internal installation and operation and must not be used for any other purpose.
- Do not locate the heater directly below a fixed socket outlet or connection box.
- Please ensure that the minimum clearance area is adhered to as per Fig. 1.
- Do not locate the heater in close proximity to curtains or other fabrics or materials. In humid areas such as bathrooms and kitchens, the connection box must be installed at least 250mm above the floor.
- Do not install the heater in a draught likely to affect the control setting.
- Do not locate the heater in any area that may store or contain paint, fuel or other flammable liquids.

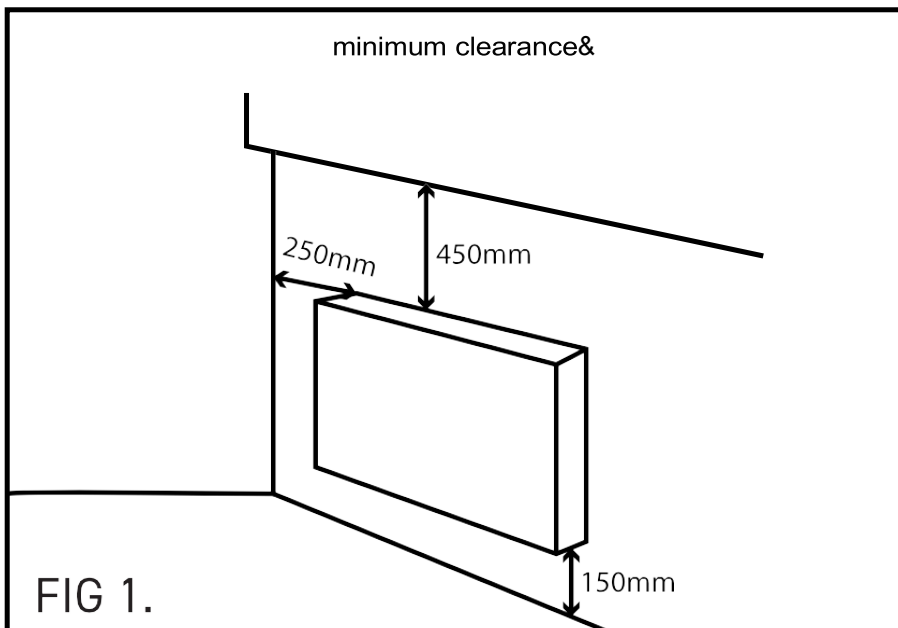

## How to Install the Panel Heater

Please use the mounting brackets supplied. The heater should be positioned observing the minimum clearances stated around the heater - see Fig. 1

**Step 1.** First remove the wall bracket from the rear housing. Unscrew the screws located on the top of the 2 vertical bars of the wall bracket.

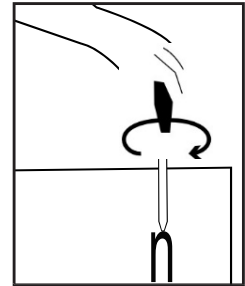

**Step 2.** Then pull out the top bar by pressing firmly both upper parts slotted into the rear housing. Slide down the wall bracket in order to remove it from the rear housing.

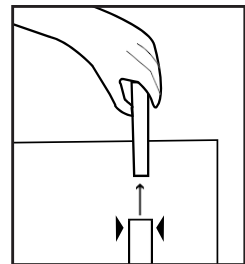

**Step 3.** Fix the wall bracket securely to the wall through the 4 screw holes provided.

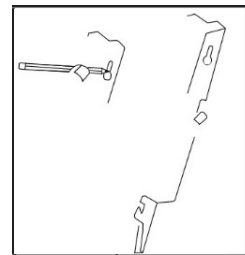

**Step 4.** Raise the heater to upright position. Present the heater and engage 2 slots of the bottom parts of the wall brackets in the wall heater's rear enclosure then pull up the heater. Then engage 2 slots of the upper parts of the wall bracket and tighten the 2 screws in order to lock the device.

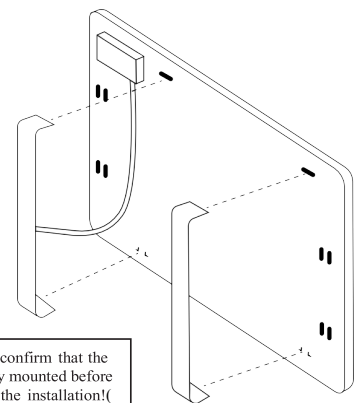

Please check to confirm that the heater is securely mounted before continuing with the installation!

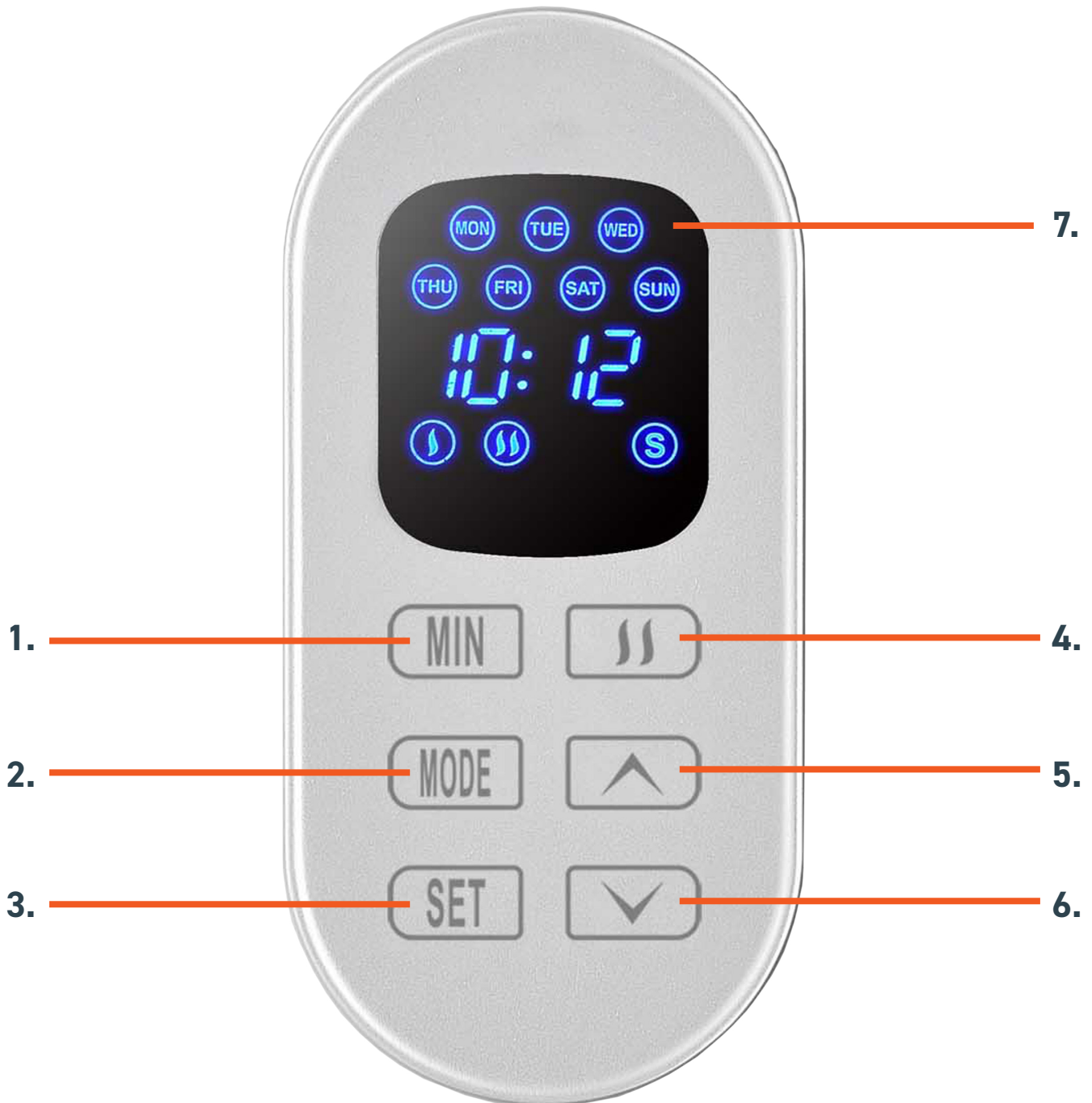

### Touch Controls

1. Minute Button
2. Hour Button & Mode Switched
3. Weekly Button & Function Selection
4. Heat Button

5. Temperature Up & Timer Heat On
6. Temperature Down & Timer Heat Off
7. Display

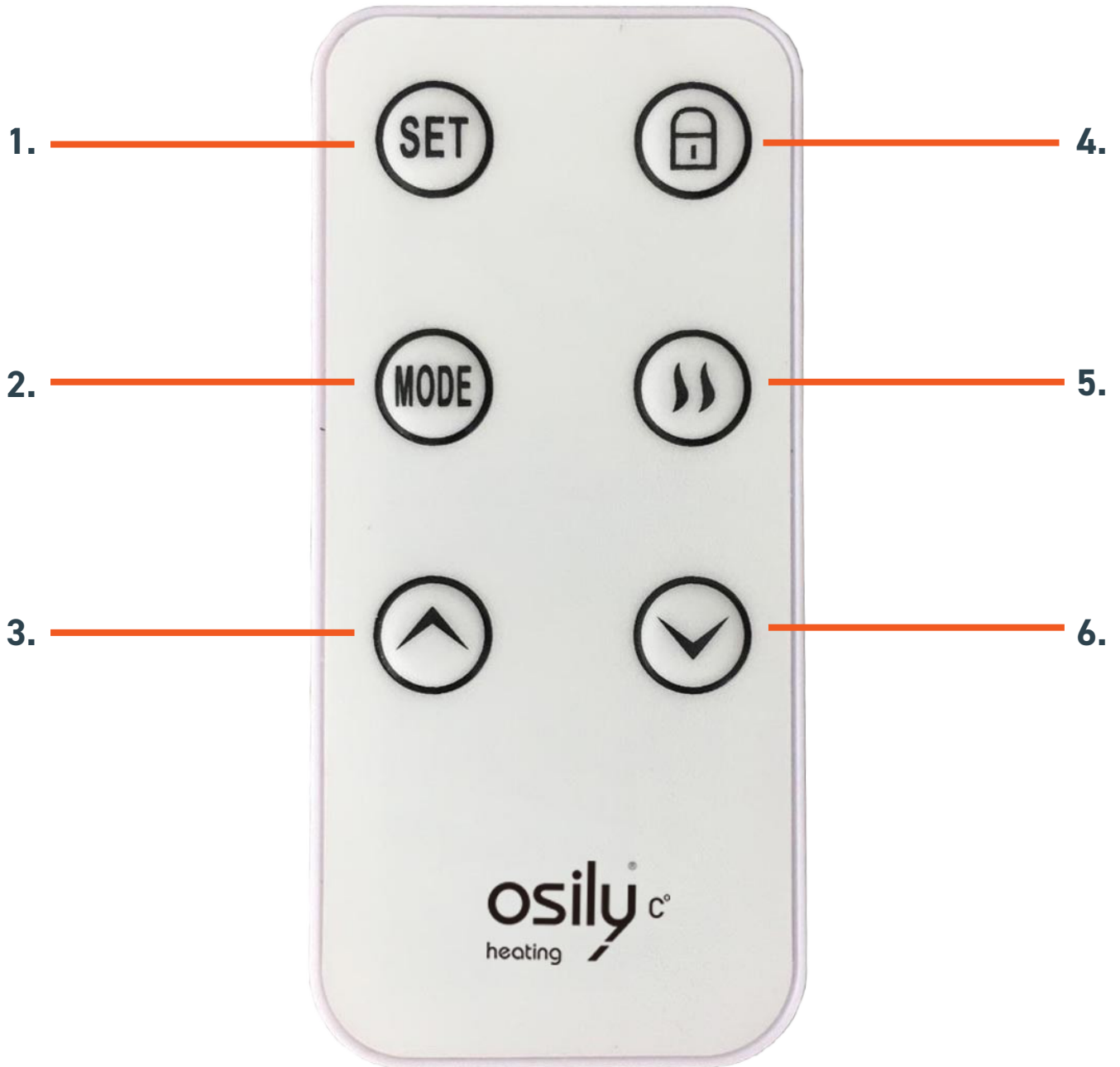

## Remote Controls

- 1. Weekly Button & Function Selection
- 2. Hour Button & Mode Switched
- 3. Temperature Up & Timer Heat On

- 4. Lock Button
- 5. Heat Button
- 6. Temperature Down & Timer Heat Off

## Operation

### Turning On

The unit should be turned on using the power switch on the side. The unit has 3 modes. Press the SET (SET) button to change the heater into the desired mode. The current mode will be indicated on the display

- (P) Standby Mode
- (S) On
- (W) Weekly Timer Mode

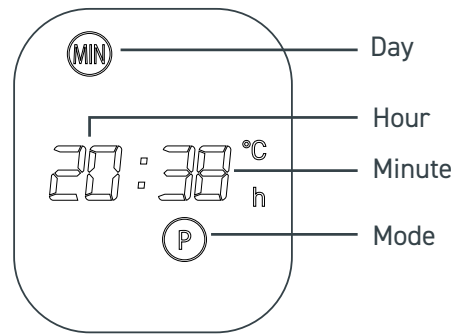

### Setting the Day and Time

With the heater in Standby Mode: Display will show P (P)

Press and hold the MODE (MODE) button to set the hour

Press and hold the MIN (MIN) button to set minute

Press and hold the SET (SET) button to set the day

### Heat Level

Press the SET (SET) button to put the heater into ON mode (S) the heat level icon will display (SSS), press this button to change between high heat setting and low heat options:

- (SS) Low Heat
- (SSS) High Heat

### Temperature Adjustment



Whilst in ON mode use the UP (▲) and DOWN (▼) buttons to adjust the desired temperature (Range of 5°-40°C). The display shows the current detected room temperature on the left and the desired room temperature on the right.

### Child Lock

Press and hold the HEAT (SSS) button for 5 seconds and the lock symbol (🔒) will be displayed.

All buttons are deactivated. To exit the child lock, press and hold the HEAT (SSS) button again for 5 seconds.





## Weekly Timer

To Change the heater into Weekly timer mode. Press the SET  button until "W" is displayed  
Press the  button to choose between the following pre- programmed heating periods:

1. Monday to Friday
2. Monday to Saturday
3. Individual days
4. Monday, Wednesday, Friday
5. Tuesday, Thursday, Saturday
6. Weekend
7. Monday to Wednesday
8. Thursday to Saturday
9. Monday to Sunday

Once the pre set heating period has been selected e.g. 1. for operation Monday to Friday then each single hour starting from midnight needs to be assigned to either an on or off setting, for all 24 hours.

Therefore, for example to set the heater to be on from 06.00 until 08.00am, and then on at 18.00 until 22.00 please programme as follows.

1. Press the DOWN  button 6 times the display will show 06.00  
(this will set all hours to off until 06.00)
2. Now press the UP  button twice the display will show 08.00  
(this will set the heater to be on for 2 hours until 08.00)
3. Now press the DOWN  button 10 times to set the heater to be off until 18.00.
4. Now press the UP  button 4 times to set the heater to be on until 22.00.
5. Now press the DOWN  button to set the last 2 hours of the day until midnight to set the heater to be off.

While the unit is operating under the weekly timer, it will heat upto the temperature set within the ON mode.

**Notes:** When the room temperature reaches the desired level, the heater will change to Low Heat mode. When room temperature is 2 degrees over the desired temperature, the heater will enter standby mode. The heater will resume operation when the temperature drops 2 degrees below the desired temperature.

## Technical Specification

PART NO.	POWER (KW)	VOLTAGE RANGE	FREQUENCY	IP RATING	OPERATION CURRENT (A)	ROOM SIZE	DIMENSIONS (WDXH)
OSPH1000E	1	220-240V	50-60 Hz	IP24	4.3	10mSQ	600 x 90 x 380 mm
OSPH1500E	1.5	220-240V	50-60 Hz	IP24	6.5	15mSQ	760 x 90 x 380 mm
OSPH2000E	2	220-240V	50-60 Hz	IP24	8.7	20mSQ	920 x 90 x 380 mm

## Trouble Shooting

Please note that there are no user serviceable parts in this heater. Disassembling this product will invalidate the warranty.

ISSUE	POSSIBLE REASON	SOLUTION
No Power	<ol style="list-style-type: none"> <li>1. Power cord is unconnected</li> <li>2. There is no power from socket</li> <li>3. The power switch on the rear of the unit is turned off.</li> </ol>	<ol style="list-style-type: none"> <li>1. Connect the power cord</li> <li>2. Check socket is turned on</li> <li>3. Ensure the power switch on the rear of the unit is in the on position</li> </ol>
Odour emission from unit	<ol style="list-style-type: none"> <li>1. New unit. When the heater is used for the first time it is possible that a odour may be omitted, this is normal and will soon disappear.</li> </ol>	N/A
Strong vibrations and noise	<ol style="list-style-type: none"> <li>1. The heater may not be securely fixed to the wall</li> </ol>	<ol style="list-style-type: none"> <li>1. Check that the heater is fixed securely to the wall</li> </ol>

## Disposal



This symbol indicates that this product must not be placed in general household waste. It should be sent to a separate recycling facility for recovery, check Local Authorities for details. By responsible recycling and separating this product from other household waste it will help protect the environment and human health, as the volume of waste sent to incinerators or landfill sites will be reduced and natural resources conserved

## Heat Output

ITEM	SYMBOL	VALUE	UNIT
Nominal heat output	P nom	1.0	kW
Minimal heat output	P min	1.5	kW
Maximum continuous output	P max	2.0	kW

## Auxiliary Electricity Consumption

ITEM	SYMBOL	VALUE	UNIT
At Nominal heat output	el max	N/A	kW
At Minimal heat output	el min	N/A	kW
In Standby mode	el sb	0.001742	kW

## Type of heat input, for electric storage local space heaters only (select one)

ITEM	SYMBOL
Manual heat charge control, with integrated thermostat	No
Manual heat charge control with room and/or outdoor temperature feedback	No
Electronic heat charge control with room and/or outdoor temperature feedback	No
Fan assisted heat output	No

### Type of heat output/room temperature control (select one)

ITEM	SYMBOL
Single stage heat output and no room temperature control	No
Two or more manual stages, no room temperature control	No
With mechanical thermostat room temperature control	No
With electronic room temperature control	No
With electronic room temperature control plus day timer	No
With electronic room temperature control plus week timer	Yes

### Other control options (multiple selections possible)

ITEM	SYMBOL
Room temperature control with presence detection	No
Room temperature control, with open window detection	No
With distance control option	No
With adaptive start control	Yes
With working time limitation	Yes
With black bulb sensor	No

**MADE IN PRC**

AER, Zac du Caillou, Rue Jules Verne, 69630, Chaponost, France  
 YESSS House, Unit B Foxbridge Way, Normanton, WF6 1TN, UK

